

# ENERGY<sup>®</sup>

Power for life

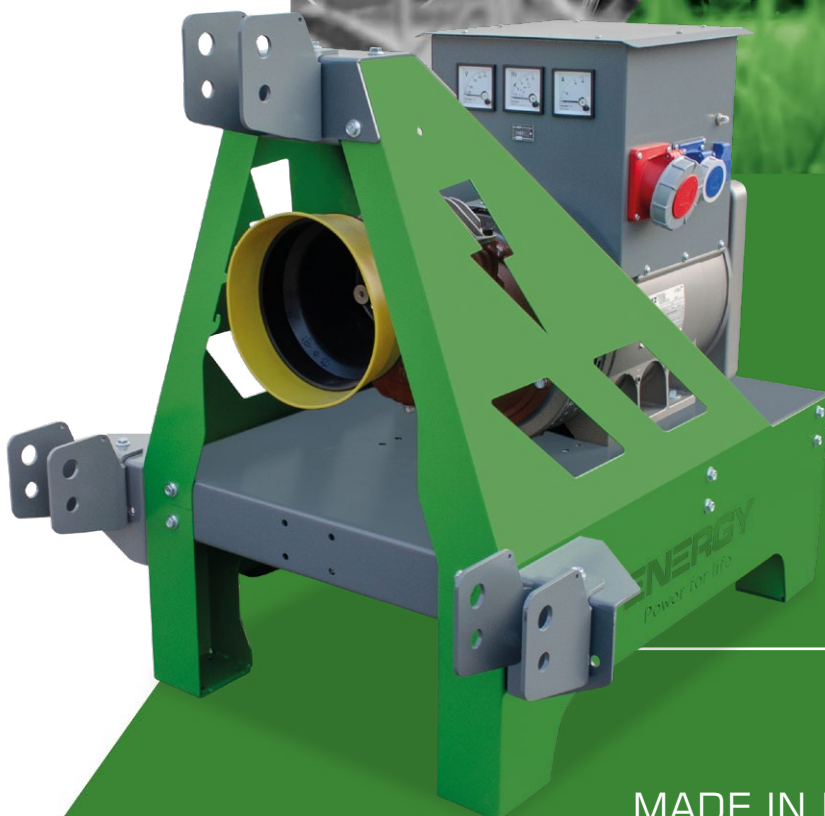

 Agripower  
Range

English - Deutsch - Italiano

MADE IN ITALY



MADE IN ITALY

# Agripower Range

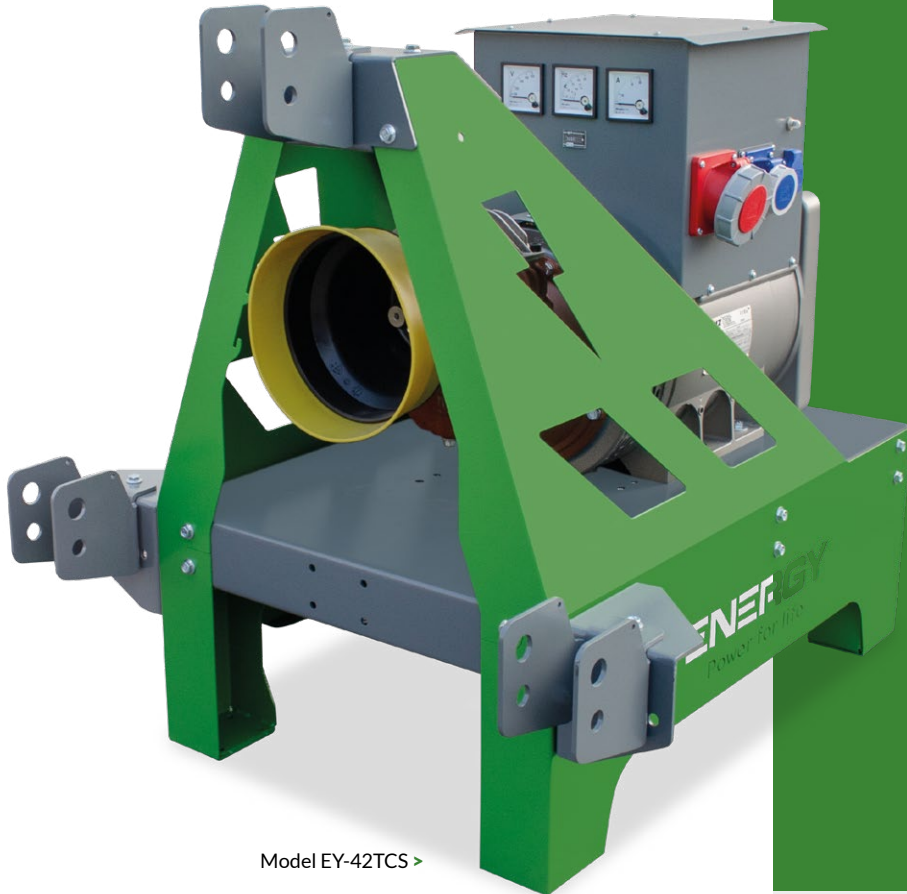

Model EY-42TCS >

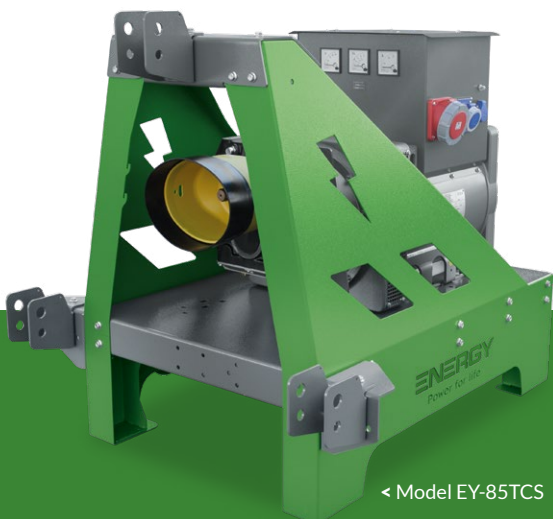

< Model EY-85TCS

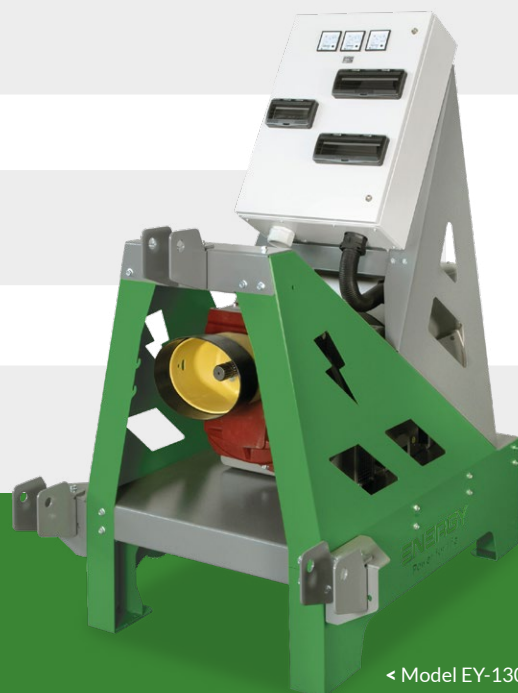

< Model EY-130TCS

🇬🇧 Excellent to use on farms or by anyone who has a tractor, electric generators for tractor coupling are driven by the tractor shaft drive.

The connection to these power generators is through the power take-off of the tractor. They can be transported by the vehicle and taken into the countryside, where no electric current is on hand.

For these electric generators *Energy* ensures an **exceptional quality/price ratio**: they are reliable, durable machines and have reduced running costs.

🇩🇪 Sie eignen sich hervorragend für den Einsatz in landwirtschaftlichen Betrieben oder für alle, die einen Traktor besitzen, und werden von der Zapfwelle des Traktors angetrieben.

Der Anschluss an diese Stromerzeuger erfolgt über die Zapfwelle des Traktors. Sie können vom Traktor aus transportiert und mit aufs Land genommen werden, wo es keinen Strom gibt.

Für diese Stromerzeuger bietet *Energy* ein **hervorragendes Preis-Leistungs-Verhältnis**: Sie sind zuverlässig, langlebig und die Betriebskosten sind gering.

🇮🇹 Eccellenti per essere utilizzati in aziende agricole o da chiunque disponga di un trattore, i gruppi elettrogeni per attacco a trattore vengono azionati dal cardano del trattore.

La connessione a questi generatori di corrente è effettuata attraverso la presa di forza del trattore. Possono essere trasportati dal mezzo e portati anche in campagna, dove non è disponibile la corrente elettrica.

Per questi gruppi elettrogeni *Energy* assicura un **eccezionale rapporto qualità/prezzo**: sono macchine affidabili, resistenti e i costi per gestirle sono ridotti.

# Standard Configuration

Standard Konfiguration / Configurazione standard



- 🇬🇧 **BASE FRAME:** solid base frame made of sheet metal painted with double-component epoxy powders, including 3-point connections to connect the generator with tractor categories I II III.
- 🇩🇪 **GRUNDRAHMEN:** Massiver Grundrahmen aus mit Zweikomponenten-Epoxidpulver lackiertem Blech, inklusive 3-Punkt-Aufnahme für Traktoren der Kategorien I II III.
- 🇮🇹 **BASAMENTO:** solido Basamento di lamiera verniciato a polveri epossidiche a doppio componente, comprensivo di attacchi a 3 punti per collegare il generatore con le categorie di trattore I II III.



- 🇬🇧 **ALTERNATOR:** high quality Made in Italy, selected from LINZ and MECCALTE brands.
- 🇩🇪 **GENERATOR:** Hochwertige Generatoren der Marken LINZ und MECCALTE hergestellt in Italien.
- 🇮🇹 **ALTERNATORE:** di alta qualità Made in Italy, selezione tra i brand LINZ e MECCALTE.

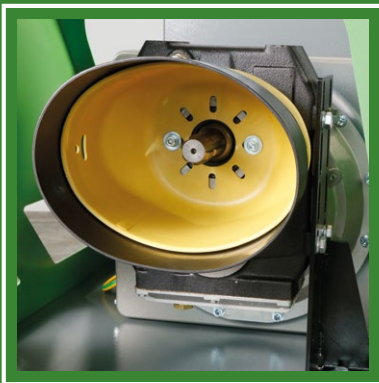

- 🇬🇧 **GEARBOX:** high quality and suitable for intensive work, selection from the COMER and Bondioli & Pavesi brands. Supplied with protective cap and gear oil of first filling.
- 🇩🇪 **GETRIEBE:** Die hochwertigen Marken COMER und Bondioli & Pavesi sind für den anspruchsvollen Dauereinsatz bestens geeignet. Lieferung mit Schutzkappe und gefülltem Getriebeöl.
- 🇮🇹 **MOLTIPLICATORE DI GIRI:** di alta qualità ed adatto per lavoro intensivo, selezione tra i brand COMER e Bondioli & Pavesi. Fornito con cuffia di protezione e olio ingranaggi di primo riempimento.



- 🇬🇧 **ELECTRICAL PANEL:** Composed of analogue instruments such as Voltmeter, Ammeter, Frequency Meter, Hour Meter. Full power three-phase CEE socket protected by Magnetic Circuit Breaker (MCB) and differential circuit breaker (protection against overload and short circuit + operator protection against electrical dispersion), 16Amp single-phase CEE socket protected by Magnetic Circuit Breaker (MCB), German Schuko socket protected by a thermal protection. IP44 protection rating.
- 🇩🇪 **SCHALTAFEL:** Bestehend aus den analogen Instrumenten Voltmeter, Amperemeter, Frequenzmesser und Betriebsstundenzähler. Dreiphasige CEE-Steckdose mit voller Leistung, einphasige 16-A-CEE-Steckdose, geschützt durch Leitungsschutzschalter sowie einer Schuko-Steckdose. Alle Steckdosen sind mit einem Leitungsschutzschalter (Überlast und Kurzschluss) sowie einem zentralen Fehlerstromschutz (FI) ausgestattet.
- 🇮🇹 **QUADRO ELETTRICO:** Composto da strumenti analogici quali Voltmetro, Amperometro, Frequenzmetro, Contatore. Presa CEE trifase di piena potenza protetta da interruttore magnetotermico differenziale (protezione contro sovraccarico e cortocircuito + protezione dell'operatore in caso di dispersione), Presa CEE monofase 16Amp protetta da interruttore magnetotermico di protezione, Presa Schuko tedesca protetta da termico di protezione. Grado di protezione IP44.

# Technical Table / Technische Tabelle / Tabella Tecnica



**3000**  
giri/min  
RPM

**For emergency use**  
Für Notfallnutzung  
Per un utilizzo di Emergenza



**10-40**  
kVA

	Model Modell Modello	Electrical Prime power PRP Dauerleistung PRP Potenza Elettrica in Continuo PRP		General Breaker size Leistungsschaltergrösse Taglia interruttore generale	Type of Voltage regulation Art der Spannungsregelung Tipo di regolazione della tensione	Input revolution Eingehende Umdrehungen Giri in entrata	HP tractor HP Zugmaschine HP trattore	Weight Gewicht Peso
		[kVA]	[kW]					
<b>S</b>	EY-10TC	10	8	16	Compound / AVR	430	20	160
	EY-16TC	16	12,8	20	Compound / AVR	430	30	170
	EY-22TC	22	17,6	32	Compound / AVR	430	40	195
	EY-27TC	27	22,5	40	Compound / AVR	430	45	240
	EY-30TC	30	24	40	Compound / AVR	430	60	260
	EY-40TC	40	32	63	Compound / AVR	430	80	270



**1500**  
giri/min  
RPM

**For continuous use**  
Für Dauereinsatz  
Per un utilizzo Continuo



**10-160**  
kVA

	Model Modell Modello	Electrical Prime Power PRP Dauerleistung PRP Potenza Elettrica in Continuo PRP		General Breaker size Leistungsschaltergrösse Taglia interruttore generale	Type of Voltage regulation Art der Spannungsregelung Tipo di regolazione della tensione	Input revolution Eingehende Umdrehungen Giri in entrata	HP tractor HP Zugmaschine HP trattore	Weight Gewicht Peso
		[kVA]	[kW]					
<b>S</b>	EY-10TCS	10	8	16	Compound / AVR	430	20	175
	EY-15TCS	15	12	20	Compound / AVR	430	30	200
	EY-20TCS	20	16	32	Compound / AVR	430	40	235
	EY-25TCS	25	20	32	Compound / AVR	430	45	250
	EY-30TCS	30	24	40	Compound / AVR	430	60	265
	EY-42TCS	42	33,6	63	AVR	430	80	325
<b>M</b>	EY-60TCS	60	48	80	AVR	395	120	470
	EY-75TCS	75	60	100	AVR	395	130	465
<b>L</b>	EY-85TCS	85	68	125	AVR	420	150	540
	EY-100TCS	100	80	160	AVR	500	160	615
<b>XL</b>	EY-130TCS	130	104	250	AVR	500	180	690
	EY-160TCS	160	128	250	AVR	750	280	890

## Dimensions / Abmessungen / Dimensioni

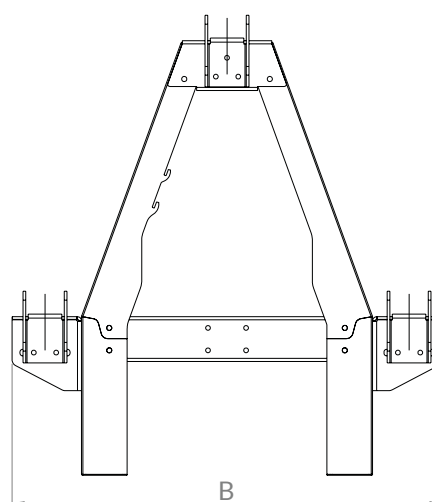
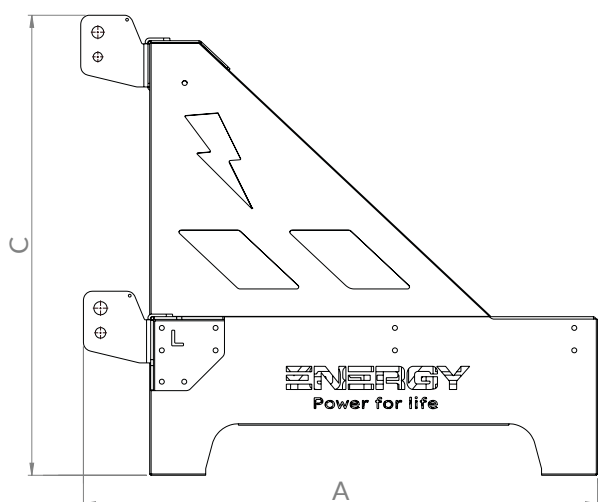

**S**

A: 1148 mm  
B: 960 mm  
C: 1027 mm

**M**

A: 1321 mm  
B: 990 mm  
C: 1099 mm

**L**



A: 1349 mm  
B: 1092 mm  
C: 1140 mm

**XL**

A: 1582 mm  
B: 1058 mm  
C: 1864 mm





**OPT-AGR-003**

-  Automatic Voltage Regulator with three-phase sensing (AVR) Accuracy +/-1%.
-  Automatische Spannungsregelung mit 3-phasiger Messung (AVR), Genauigkeit +/-1%.
-  Regolatore Elettronico di tensione con rilevamento trifase (AVR) Precisione +/-1%.





**OPT-AGR-004**

-  **Low/high voltage and frequency protection device:** that read all phases Voltage and Frequency + protection and general breaker shut down in case of : phase loss, phase sequence, max-min voltage, max-min frequency and voltage asymmetry. All parameters settable by energy and also by end user electrician.
-  **Spannungs- und Frequenzüberwachung:** Überwachung der Spannungen aller 3 Phasen inkl. Abschalten bei Phasenausfall, falscher Phasenfolge, Über- oder Unterspannung, Spannungsasymmetrie sowie Über- oder Unterfrequenz. Alle Werte sind voreingestellt und veränderbar.
-  **Strumento di protezione per bassa/alta tensione e frequenza:** che legge il voltaggio su tutte le fasi e la frequenza e fa scattare l'interruttore in caso di: perdita di fase, errata sequenza di fase, sovra/sotto tensione, sovra/sotto frequenza e asimmetria di tensione. Tutti i parametri regolabili da energy e dall'elettricista dell'utente finale.





**OPT-AGR-005**

-  Manual transfer switch (MTS) 1, 0, 2 (MAINS / 0 / GENERATOR).
-  Manueller Transferschalter (MTS) 1, 0, 2 (NETZ - AUS - GENERATOR).
-  Commutatore manuale di linea 1, 0, 2 (RETE / 0 / GENERATORE).



**OPT-AGR-014**

-  **Distribution panel 16amp:** input plug: 1 x CEE 16A 5P 400V - output sockets: 1 x CEE 16A 5P 400V + 4 x schuko 16A 250V IP54
-  **Verteiler panel 16amp:** eingangsstecker: 1 x CEE 16A 5P 400V - steckdose: 1 x CEE 16A 5P 400V + 4 x schuko 16A 250V IP54
-  **Quadro distribuzione 16amp:** spina in ingresso: 1 x CEE 16A 400A 5P - prese in uscita: 1 x CEE 400V 16A 5P + 4 x schuko 16A 250V IP54





**OPT-AGR-015**

-  **Distribution panel 32amp:** input plug: 1 x CEE 32A 5P 400V with 2m cable h07rn-f5g4 mm2 - output sockets: 1 x CEE 32A 5P 400V + 1 x CEE 16A 5P 400V + 3 x schuko 16A 250V IP54 - protections: 1 rcd 63A/4/0.03A
-  **Verteiler panel 32amp:** eingangsstecker: 1 x CEE 32A 5P 400V mit 2m kabel h07rn-f5g4 mm2 steckdose: 1 x CEE 32A 5P 400V + 1 x CEE 16A 5P 400V + 3 x schuko 16A 250V IP54 schutz: 1 fi 63A/4/0.03A
-  **Quadro distribuzione 32amp:** spina in ingresso: 1 x CEE 32A 400V 5P, 2m di cavo h07rn-f5g4 mm2 - prese in uscita: 1 x CEE 400V 32A 5P + 1 x CEE 400V 16A 5P + 3 x schuko 16A 250V IP54 - protezioni: 1 differenziale 63A/4/0.03A





**OPT-AGR-016**

-  **Distribution panel 63a:** input plug: 1 x CEE 63A 5P 400V with 2m cable h07rn-f 5g16 mm2 output sockets: 1 x CEE 32A 5P 400V + 2 x CEE 16A 5P 400V + 3 x schuko 16A 250V IP54 protections: 1 rcd 63A/4/0.03A
-  **Verteiler panel 63amp:** eingangsstecker: 1 x CEE 63A 5P 400V mit 2m kabel h07rn-f 5g16 mm2 steckdose: 1 x CEE 32A 5P 400V + 2 x CEE 16A 5P 400V + 3 x schuko 16A 250V IP54 schutz: 1 fi 63A/4/0.03A
-  **Quadro distribuzione 63amp:** spina in ingresso: 1 x CEE 63A 400V 5P, 2m di cavo h07rn-f 5g16 mm2 prese in uscita: 1 x CEE 400V 32A 5 poli + 2 x CEE 400V 16A 5 poli + 3 x schuko 16A 250V IP54 protezioni: 1 differenziale 63A/4/0.03A



**OPT-AGR-017**

-  CEE Plug 16A/32A/63A/125A
-  CEE Stecker 16A/32A/63A/125A
-  Spine CEE 16A/32A/63A/125A

# Optional

## Mechanics / *mechanik* / *meccanici*



OPT-AGR-006

- 🇬🇧 IP44 filters kit for alternator (intake and expulsion) with replaceable filter element.
- 🇩🇪 IP44 Filtereinsatz für Generator (Einlass und Auslass) mit austauschbaren Elementen.
- 🇮🇹 Kit filtri IP44 per alternatore (aspirazione ed espulsione) con panno filtrante sostituibile.

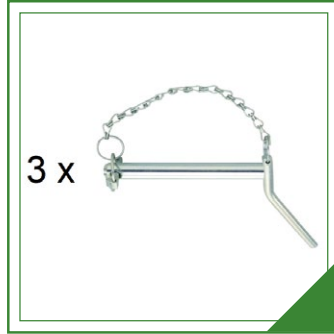

OPT-AGR-007

- 🇬🇧 **Kit 3 points pins for tractors cat. I or cat.II:** 2 x low points complete with snap pin with chain + 1 x top point complete with snap pin with chain.
- 🇩🇪 **3-punkte-haken kit für traktor cat. I oder II:** 2 x haken für die unteren punkte inklusive knappstifte mit kette + 1 x haken für den oberen punkt inklusive knöpfe mit kette.
- 🇮🇹 **Kit ganci 3 punti per trattori categoria I o II:** 2 x agganci per i punti inferiori compresi di spina a scatto con catenella + 1 x aggancio per il punto superiore compreso di spina a scatto con catenella.



OPT-AGR-008

- 🇬🇧 **Extra protection bars:** Extra protection bars that protect the base frame and the electrical panel. Not available for models EY-100TCS and EY-130TCS.
- 🇩🇪 **Schutzrahmen:** extra schutz für rahmen und schaltschrank, nicht verfügbar für die modelle EY-100TCS und EY-130TCS.
- 🇮🇹 **Kit barre protezione:** barre di protezione aggiuntive che proteggono basamento e quadro elettrico. Non disponibile per i modelli EY-100TCS ed EY-130TCS.



OPT-AGR-009

- 🇬🇧 **Kit wheels for manual movements:** supplied separately in a carton box with screws and instructions for mounting. 2 x fix wheels + 2 x rotatable with breaks wheels. Total load acceptable: 800kg.
- 🇩🇪 **Transportrollen:** 2 x feste Räder, 2 x schwenkbare Räder mit Bremse im Karton als Montageset, zulässige Höchstlast 800kg
- 🇮🇹 **Kit ruote per movimentazione manuale:** fornite sciolte su apposita scatola, con viteria e istruzioni per il montaggio, composto da 2 ruote fisse e 2 girevoli con freni. Carico totale accettato: 800kg.



OPT-AGR-010

- 🇬🇧 **Kit trailer for ground movements:** supplied with axel and 2 x pneumatic tires + shaft with variable inheight stabilizer. Not approved for road circulation.
- 🇩🇪 **Anhänger-Set:** bestehend aus Achse inkl. Luftreifen, Deichsel und Abstellstütze. Nicht für den Straßenverkehr zugelassen.
- 🇮🇹 **Kit carrello per traino:** comprensivo di assale con 2 ruote pneumatiche, timone, stabilizzatore regolabile in altezza. Non omologabile per la circolazione stradale.



OPT-AGR-011

- 🇬🇧 **Cardan holder kit:** to conveniently place the cardan when it is not connected to the tractor.
- 🇩🇪 **Zapfwellen-Halterung:** bequemes Aufbewahren der Zapfwelle am Generator.
- 🇮🇹 **Kit porta cardano:** per appoggiare comodamente il cardano quando non è connesso al trattore.



OPT-AGR-012

- 🇬🇧 **Earthing rod 1m length:** 1 x earthing rod 5mm thickness, complete with double clamp and 2m of cable.
- 🇩🇪 **Erdstange:** 1 x erdstange dicke 5 mm länge 1 mt + doppelte klemmenklemme + 2 mt kabel.
- 🇮🇹 **Picchetto terra:** 1 x picchetto di terra sp. 5mm lunghezza 1mt + morsetto terminale doppio + 2mt di cavo.



OPT-AGR-013

- 🇬🇧 **Customization of the base frame:** with an order of minimum 10 pcs it's possible to have the sides of the base frame with a different color from the standard and also to lasercut the customer's logo.
- 🇩🇪 **Individualisierung des Grundrahmens:** Bei einer Bestellung von mindestens 10 Stück ist es möglich, die Seiten des Grundrahmens in einer anderen Farbe als der Standardfarbe zu gestalten und auch das Logo des Kunden per Laser einzuschneiden.
- 🇮🇹 **Customizzazione del basamento:** con un ordine di almeno 10 pezzi è possibile richiedere i fianchi del basamento con colorazione diversa dallo standard ed anche le scritte a laser con logo del cliente.

# ISO Panel / ISO-Schalttafel / Quadro ISO

## ISO EASY



### OPT-AGR-001

**ISO EASY panel:** panel with voltmeter, ammeter, frequencymeter, hourscounter, with cee socket 5P 400V 7hr or 1hr + 1 x CEE 5P 400V socket + 1 x schuko socket + isolator device with 1,0,2 selector.

- 0: off
- 1: house: 1 x CEE 5P 7h or 1hr, field sockets not working.
- 2: Field 1 x CEE socket 5P 400V + 1 x schuko socket, with isolator control. House socket not working.

**ISO EASY panel:** schaltschrank mit voltmeter, amperemeter, frequenzmesser, stundenzähler, betriebwahlschalter mit 1 steckdose für das haus (CEE 7h oder 1h) und 2 steckdosen für das feld (1 x CEE 5P 400V 6h volle leistung + 1 x schuko) + isolatorüberwachung.

- 0: off
- 1: haus 1 x CEE 5P 7h or 1hr, feld steckdosen arbeiten nicht
- 2: feld 1 x CEE steckdosen 5P 400V + 1 x schuko, mit isolator control. Haus steckdose arbeitet nicht.

**Quadro ISO EASY:** completo di voltmetro, amperometro, frequenzimetro, contaore, presa CEE 5P 400V 7hr o 1hr + presa CEE 5P 400V + presa schuko 230V + isolatore di controllo con selettore 1/0/2.

- 0: Off
- 1: "Casa": 1 x presa CEE 5P 400V 7h o 1hr, le prese "campo" non erogano corrente.
- 2: "Campo": 1 x presa CEE 5P 400V + 1 x presa schuko, con isolatore di controllo. La presa "casa" non eroga corrente.

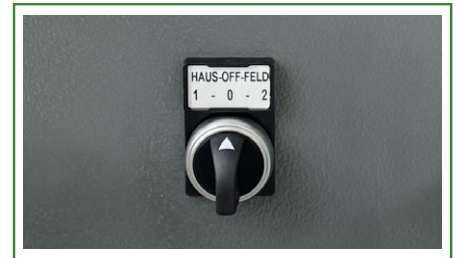

## ISO FULL

### OPT-AGR-002

**ISO FULL panel:** panel with voltmeter, ammeter, frequencymeter, hourscounter, with CEE socket 5P 400V 7hr or 1hr + 2 x CEE sockets 5P 400V + 2 x schuko sockets + isolator device with 0,1,2 selector, emergency push button. No differential breaker, no dmk70 device

- 0: off
- 1: house: 1 x CEE 5P 7h or 1hr, field sockets not working.
- 2: Field 2 x CEE sockets 5P 400V + 2 x schuko sockets, with isolator control. House socket not working.

**ISO FULL panel:** schaltschrank mit voltmeter, amperemeter, frequenzmesser, stundenzähler, betriebwahlschalter mit 1 steckdose für das haus (CEE 7h oder 1h, grau) und 4 steckdosen für das feld (2 x CEE 5P 400V 6h + 2 x schuko) + isolatorüberwachung. Notfall knopf. Keine fi schutz, keine dmk70 geräte

- 0: off
- 1: haus 1 x CEE 5P 7h or 1hr, feld steckdosen arbeiten nicht
- 2: feld 2 x CEE steckdosen 5P 400V + 2 x schuko, mit isolator control. Haus steckdose arbeitet nicht.

**Quadro ISO FULL:** completo di voltmetro, amperometro, frequenzimetro, contaore, presa CEE 5P 400V 7hr o 1hr + 2 x prese CEE 5P 400V + 2 x prese schuko 230V + isolatore di controllo con selettore 1/0/2 e pulsante arresto d'emergenza.

- 0: Off
- 1: "Casa": 1 x presa CEE 5P 400V 7h o 1hr, le prese "campo" non erogano corrente.
- 2: "Campo": 2 x prese CEE 5P 400V + 2 x prese schuko + isolatore di controllo. La presa "casa" non eroga corrente.



# ENERGY®

## Power for life



Energy means autonomy, safety, and quality of life. **ENERGY** designs and industrializes reliable power generation solutions with cutting-edge technology and design. The goal is to establish itself globally as a benchmark in the industry, combining innovation and performance.



Energie bedeutet Autonomie, Sicherheit und Lebensqualität. **ENERGY** entwickelt und industrialisiert zuverlässige Lösungen zur Energieerzeugung mit modernster Technologie und Design. Das Ziel ist es, sich weltweit als Maßstab in der Branche zu etablieren, indem Innovation und Leistung vereint werden.



L'energia è autonomia, sicurezza e qualità della vita. **ENERGY** progetta e industrializza soluzioni affidabili per la produzione di energia, con tecnologie e design all'avanguardia. L'obiettivo è affermarsi a livello globale come punto di riferimento nel settore, unendo innovazione e prestazioni.

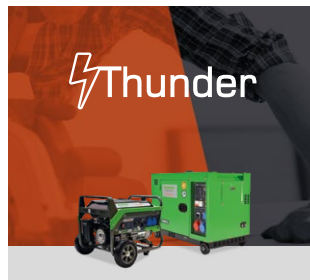

SELECTED SUPPLIERS- AUSGEWÄHLTE LIEFERANTEN - FORNITORI SELEZIONATI



**ENERGY S.R.L.**

Via del Progresso, 35 • 36054 Montebello Vicentino, VI • Italia  
T. +39 0444 450422 • [info@energy-gruppi.it](mailto:info@energy-gruppi.it) • [www.energy-gruppi.it](http://www.energy-gruppi.it)



**MADE IN ITALY**